

FILTERVÄLJAK

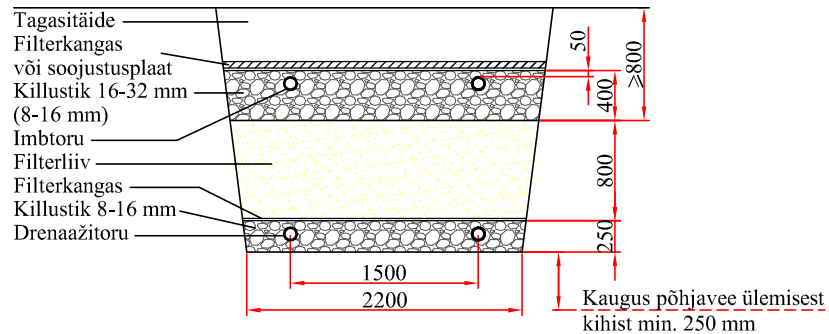

$h =$ _____ mm (standardkõrgus 600 mm)

$h_1 =$ _____ mm (standardkõrgus 1100 mm)

$h_2 =$ _____ mm (standardkõrgus 2500 mm)

Joonise nimetus: 3 M³ SEPTIK KOOS FILTERSÜSTEEMIGA

Objekt:	Joonise nr:	Mõõtkava: 1:60
Aadress:	Joonise liik:	Arh. mäрге:
Projekteerija/kuupäev/allkiri:	 Fertil OÜ, Peterburi tee 2A 11415 Tallinn, Estonia tel. (+372) 621 5392 faks (+372) 621 1259 www.fertil.ee, info@fertil.ee	